



INSTALLATION INSTRUCTIONS

Accessory

ALL-SEASON
FLOOR MATS

Application

2014 RLX

Publications No.

BII 13397

Issue Date

JAN 2013

PARTS LIST

Driver's side all-season floor mat

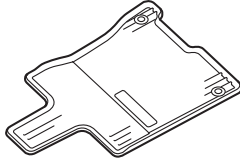

Passenger's side all-season floor mat

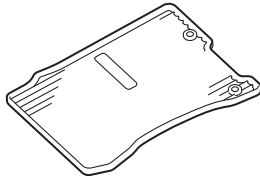

Left side rear all-season floor mat

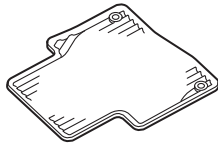

Right side rear all-season floor mat

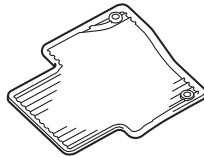

INSTALLATION

NOTE:

- Before installing the mats, identify their installation positions.
- Connect the mats to the anchors to prevent the mats from sliding forward and, for the driver's mat, possibly interfering with the pedals.
- If you remove a mat, make sure you reanchor it when you put it back in your vehicle.
- If you replace a mat, use a factory mat designed to be used with the anchors.
- If you use a non-factory mat in the driver's footwell, make sure it fits properly and that it can be used with the anchors.
- Do not put an additional mat on top of the anchored mat. An additional mat may slide forward and possibly interfere with the pedals.
- Identify each mat by the marks on the back of each mat: the mats marked "R" go on the right side of the vehicle; the mats marked "L" go on the left side.

Installing the All-Season Floor Mats

1. If equipped, remove the driver's, passenger's, and rear floor mats as described in the vehicle Owner's Manual.

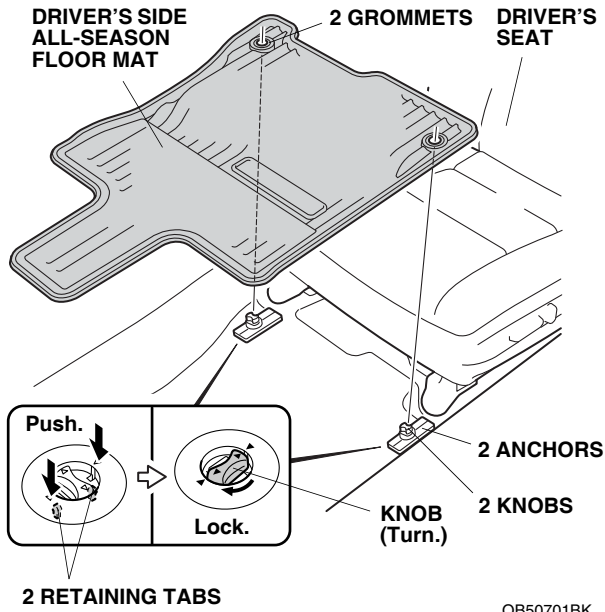

2. Place the grommets in the driver's side all-season floor mat over the anchors. Push on the grommets into the anchors to secure the retaining tabs, then turn the knobs one quarter turn to secure the all-season floor mat.
3. Place the grommets in the passenger's side all-season floor mat over the anchors. Push on the grommets into the anchors to secure the retaining tabs, then turn the knobs one quarter turn to secure the all-season floor mat.

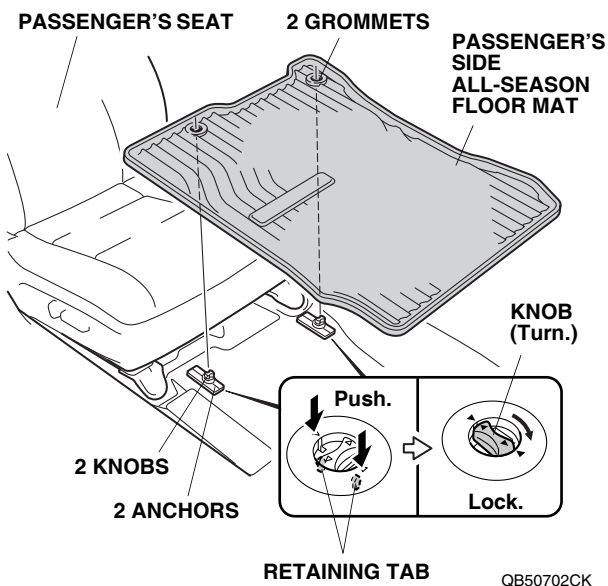

4. Place the grommets in the right side rear all-season floor mat over the anchors. Push on the grommets into the anchors to secure the retaining tabs, then turn the knobs one quarter turn to secure the all-season floor mat.

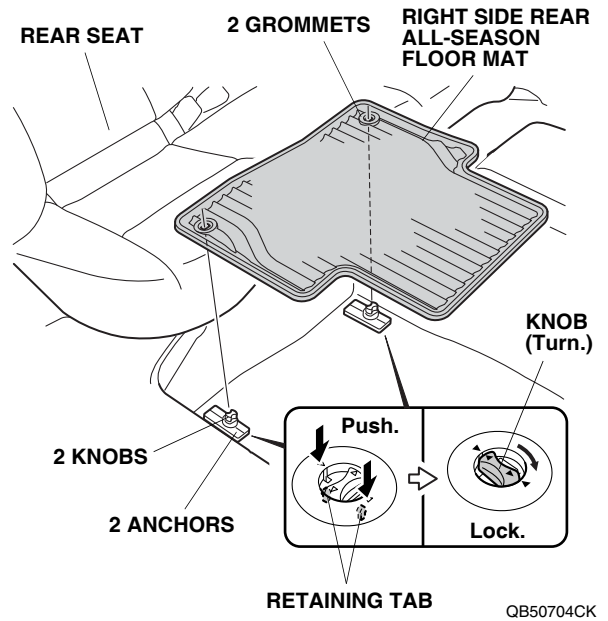

5. Place the grommets in the left side rear all-season floor mat over the anchors. Push on the grommets into the anchors to secure the retaining tabs, then turn the knobs one quarter turn to secure the all-season floor mat.

